

PRODUCT DESCRIPTION



MLA06018060

MODULAR ENCLOSURE WITH POLYCARBONATE DOOR

*representative image

TECHNICAL CHARACTERISTICS

PRODUCT CODE	MLA06018060	
DESCRIPTION	MODULAR ENCLOSURE WITH POLYCARBONATE DOOR B600 X H1800 X P600	
MATERIAL	STAINLESS STEEL AISI 304 (1.4301)	
MATERIAL FINISHING	SCOTCH BRITE	
IP PROTECTION GRADE EN 60529	IP66	
IK RATING EN 62262	IK10	
NEMA RATING 250	4X	
UL/CSA UL508A CERTIFICATION, CSA C22.2 n° 14-13	NEMA 1.12.4.4X	
DIMENSIONS	WIDTH mm	600
	HEIGHT mm	1800
	DEPTH mm	600
VIEWING DIMENSIONS	WIDTH mm	360
	HEIGHT mm	1580
FRAME	THICKNESS mm	-
	PROFILED STRUCTURE WELDED ON MICRO-CAST TRIPOD	
DOOR	THICKNESS mm	1.5
	AIS1304 STAINLESS STEEL CONCEALED HINGES , OPENING SUP. 120° POLYURETHANE GASKET (TEMPERATURE RANGE: -40°C + 90°C)	
BACK	THICKNESS mm	1.5
SIDES	THICKNESS mm	1.5
ROOF	THICKNESS mm	1.5
NUMBER OF DOORS	1	
NUMBER OF HINGES	4	
HANDLES	1	
LOCKING POINTS	4	
LOCK	ERGONOMIC HANDLE WITH 3 mm DOUBLE BIT LOCK	
SUPPLY KIT	GROUNDING ACCESSORIES AND PALLET PACKING	
PACKAGING	CARDBOARD	
WEIGHT (PLATE EXCLUDED)	m ³	74.40.00
VOLUME	Kg	1.05

(OPTIONAL) INTERNAL PLATE	PLATE CODE	MPE060180
	MATERIAL	GALVANIZED STEEL
	WIDTH mm	600
	HEIGHT mm	1720/1675
	THICKNESS mm	2.5
	OVERALL SIZE mm	28
	WEIGHT Kg	34.2

POWER DISSIPATION TABLES

POWER DISSIPATION

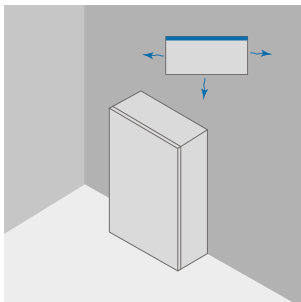

MAXIMUM DISSIPABLE POWER IN WATT (W) FOR ALLOWED OVERTEMPERATURE (T °) VALUES (EXTERNAL TEMP. + OVERTEMPERATURE = 60 ° C)

			REAR RAGAINST WALL			
W	H	D	OVERTEMPERATURE VALUES (dT)			
			25°C	30°C	35°C	40°C
mm	mm	mm	W	W	W	W
600	1800	600	445	533	622	711

POWER DISSIPATION

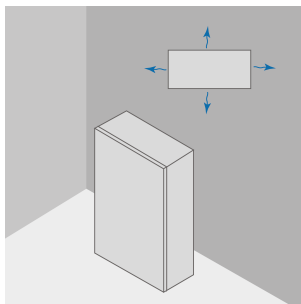

MAXIMUM DISSIPABLE POWER IN WATT (W) FOR ALLOWED OVERTEMPERATURE (T °) VALUES (EXTERNAL TEMP. + OVERTEMPERATURE = 60 ° C)

			ALL SIDES FREE			
W	H	D	OVERTEMPERATURE VALUES (dT)			
			25°C	30°C	35°C	40°C
mm	mm	mm	W	W	W	W
600	1800	600	459	551	643	735

download link CAD drawing: <https://www.compex.it/download/>

POWER DISSIPATION

 MAXIMUM DISSIPABLE POWER IN WATT (W) FOR ALLOWED OVERTEMPERATURE (T °)
 VALUES (EXTERNAL TEMP. + OVERTEMPERATURE = 60 ° C)

			EXTERNAL (COUPLED ENCLOSURES)			
			OVERTEMPERATURE VALUES (dT)			
W	H	D	25°C	30°C	35°C	40°C
mm	mm	mm	W	W	W	W
600	1800	600	418	501	585	669

POWER DISSIPATION

 MAXIMUM DISSIPABLE POWER IN WATT (W) FOR ALLOWED OVERTEMPERATURE (T °)
 VALUES (EXTERNAL TEMP. + OVERTEMPERATURE = 60 ° C)

			EXTERNAL (COUPLED ENCLOSURES, REAR AGAINST WALL)			
			OVERTEMPERATURE VALUES (dT)			
W	H	D	25°C	30°C	35°C	40°C
mm	mm	mm	W	W	W	W
600	1800	600	399	479	558	638

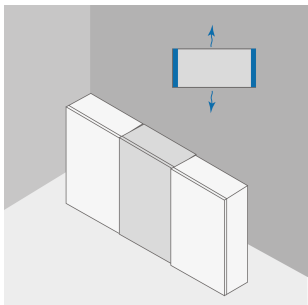
POWER DISSIPATION

 MAXIMUM DISSIPABLE POWER IN WATT (W) FOR ALLOWED OVERTEMPERATURE (T °)
 VALUES (EXTERNAL TEMP. + OVERTEMPERATURE = 60 ° C)

			MIDDLE (COUPLED ENCLOSURES)			
			OVERTEMPERATURE VALUES (dT)			
W	H	D	25°C	30°C	35°C	40°C
mm	mm	mm	W	W	W	W
600	1800	600	367	441	514	588

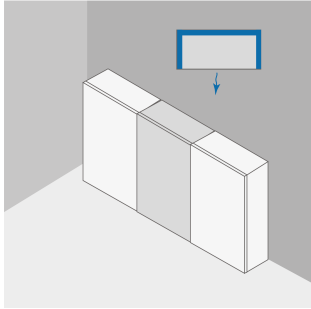
POWER DISSIPATION

 MAXIMUM DISSIPABLE POWER IN WATT (W) FOR ALLOWED OVERTEMPERATURE (T °)
 VALUES (EXTERNAL TEMP. + OVERTEMPERATURE = 60 ° C)

MIDDLE (COUPLED ENCLOSURES, REAR AGAINST WALL)			OVERTEMPERATURE VALUES (dT)			
W	H	D	25°C	30°C	35°C	40°C
			W	W	W	W
600	1800	600	353	424	494	565

POWER DISSIPATION

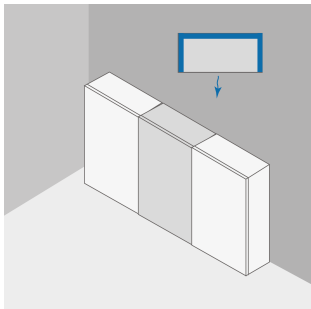
 MAXIMUM DISSIPABLE POWER IN WATT (W) FOR ALLOWED OVERTEMPERATURE (T °)
 VALUES (EXTERNAL TEMP. + OVERTEMPERATURE = 60 ° C)

MIDDLE (COUPLED ENCLOSURES, REAR AGAINST WALL), TOP NOT FREE			OVERTEMPERATURE VALUES (dT)			
W	H	D	25°C	30°C	35°C	40°C
			W	W	W	W
600	1800	600	244	292	342	390