

PRODUCT DESCRIPTION



MCA04020060

MODULAR ENCLOSURE WITH SOLID DOOR

*representative image

TECHNICAL CHARACTERISTICS

PRODUCT CODE	MCA04020060	
DESCRIPTION	MODULAR ENCLOSURE WITH SOLID DOOR B400 X H2000 X P600	
MATERIAL	STAINLESS STEEL AISI 304 (1.4301)	
MATERIAL FINISHING	SCOTCH BRITE	
IP PROTECTION GRADE EN 60529	IP66	
IK RATING EN 62262	IK10	
NEMA RATING 250	4X	
UL/CSA UL508A CERTIFICATION, CSA C22.2 n° 14-13	NEMA 1.12.4.4X	
DIMENSIONS	WIDTH mm	400
	HEIGHT mm	2000
	DEPTH mm	600
FRAME	THICKNESS mm	-
	PROFILED STRUCTURE WELDED ON MICRO-CAST TRIPOD	
DOOR	THICKNESS mm	1,5
	AIS304 STAINLESS STEEL CONCEALED HINGES , OPENING SUP. 120° POLYURETHANE GASKET (TEMPERATURE RANGE: -40°C + 90°C)	
BACK	THICKNESS mm	1,5
SIDES	THICKNESS mm	1,5
ROOF	THICKNESS mm	1,5
NUMBER OF DOORS	1	
NUMBER OF HINGES	4	
HANDLES	1	
LOCKING POINTS	4	
LOCK	ERGONOMIC HANDLE WITH 3 mm DOUBLE BIT LOCK	
SUPPLY KIT	GROUNDING ACCESSORIES AND PALLET PACKING	
PACKAGING	CARDBOARD	
WEIGHT (PLATE EXCLUDED)	Kg	59,4
VOLUME	m ³	0,48

(OPTIONAL) INTERNAL PLATE	PLATE CODE	-
	MATERIAL	-
	WIDTH mm	-
	HEIGHT mm	-
	THICKNESS mm	-
	OVERALL SIZE mm	-
	WEIGHT Kg	-

POWER DISSIPATION TABLES

POWER DISSIPATION

MAXIMUM DISSIPABLE POWER IN WATT (W) FOR ALLOWED OVERTEMPERATURE (T °)
 VALUES (EXTERNAL TEMP. + OVERTEMPERATURE = 60 ° C)



			REAR RAGAINST WALL			
W	H	D	OVERTEMPERATURE VALUES (dT)			
			25°C	30°C	35°C	40°C
mm	mm	mm	W	W	W	W
400	2000	600	324	389	454	519

POWER DISSIPATION

MAXIMUM DISSIPABLE POWER IN WATT (W) FOR ALLOWED OVERTEMPERATURE (T °)
 VALUES (EXTERNAL TEMP. + OVERTEMPERATURE = 60 ° C)



			ALL SIDES FREE			
W	H	D	OVERTEMPERATURE VALUES (dT)			
			25°C	30°C	35°C	40°C
mm	mm	mm	W	W	W	W
400	2000	600	335	402	469	536

download link CAD drawing: <https://www.compex.it/download/>

POWER DISSIPATION

 MAXIMUM DISSIPABLE POWER IN WATT (W) FOR ALLOWED OVERTEMPERATURE (T °)
 VALUES (EXTERNAL TEMP. + OVERTEMPERATURE = 60 ° C)

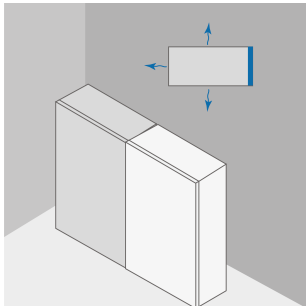

EXTERNAL (COUPLED ENCLOSURES)			OVERTEMPERATURE VALUES (dT)			
W	H	D	25°C	30°C	35°C	40°C
mm	mm	mm	W	W	W	W
400	2000	600	305	366	427	488

POWER DISSIPATION

 MAXIMUM DISSIPABLE POWER IN WATT (W) FOR ALLOWED OVERTEMPERATURE (T °)
 VALUES (EXTERNAL TEMP. + OVERTEMPERATURE = 60 ° C)

EXTERNAL (COUPLED ENCLOSURES, REAR AGAINST WALL)			OVERTEMPERATURE VALUES (dT)			
W	H	D	25°C	30°C	35°C	40°C
mm	mm	mm	W	W	W	W
400	2000	600	281	337	394	450

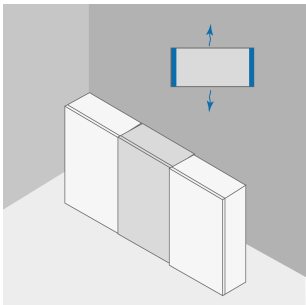
POWER DISSIPATION

 MAXIMUM DISSIPABLE POWER IN WATT (W) FOR ALLOWED OVERTEMPERATURE (T °)
 VALUES (EXTERNAL TEMP. + OVERTEMPERATURE = 60 ° C)

MIDDLE (COUPLED ENCLOSURES)			OVERTEMPERATURE VALUES (dT)			
W	H	D	25°C	30°C	35°C	40°C
mm	mm	mm	W	W	W	W
400	2000	600	247	296	346	395

POWER DISSIPATION

 MAXIMUM DISSIPABLE POWER IN WATT (W) FOR ALLOWED OVERTEMPERATURE (T °)
 VALUES (EXTERNAL TEMP. + OVERTEMPERATURE = 60 ° C)

MIDDLE (COUPLED ENCLOSURES, REAR AGAINST WALL)			OVERTEMPERATURE VALUES (dT)			
W	H	D	25°C	30°C	35°C	40°C
			W	W	W	W
mm	mm	mm	W	W	W	W
400	2000	600	238	286	334	600

POWER DISSIPATION

 MAXIMUM DISSIPABLE POWER IN WATT (W) FOR ALLOWED OVERTEMPERATURE (T °)
 VALUES (EXTERNAL TEMP. + OVERTEMPERATURE = 60 ° C)

MIDDLE (COUPLED ENCLOSURES, REAR AGAINST WALL), TOP NOT FREE			OVERTEMPERATURE VALUES (dT)			
W	H	D	25°C	30°C	35°C	40°C
			W	W	W	W
mm	mm	mm	W	W	W	W
400	2000	500	180	215	251	287