

PRODUCT DESCRIPTION



FCA16018040

COMPACT ENCLOSURE WITH SOLID DOOR. 2 DOORS

*representative image

TECHNICAL CHARACTERISTICS

PRODUCT CODE	FCA16018040	
DESCRIPTION	COMPACT ENCLOSURE WITH SOLID DOOR. 2 DOORS B1600 X H1800 X P400	
MATERIAL	STAINLESS STEEL AISI 304 (1.4301)	
MATERIAL FINISHING	SCOTCH BRITE	
IP PROTECTION GRADE EN 60529	IP55	
IK RATING EN 62262	IK10	
NEMA RATING 250	12	
UL/CSA UL508A CERTIFICATION, CSA C22.2 n° 14-13	NEMA 1.12	
DIMENSIONS	WIDTH mm	1600
	HEIGHT mm	1800
	DEPTH mm	400
FRAME	THICKNESS mm	1,5
	CONTINUOUSLY BENT AND WELDED SINGLE-STRUCTURE BODY	
DOOR	THICKNESS mm	1,5
	AISI304 STAINLESS STEEL CONCEALED HINGES , OPENING SUP. 120° POLYURETHANE GASKET (TEMPERATURE RANGE: -40°C + 90°C)	
BACK	THICKNESS mm	1,5
SIDES	THICKNESS mm	-
ROOF	THICKNESS mm	-
NUMBER OF DOORS	2	
NUMBER OF HINGES	8	
HANDLES	2	
LOCKING POINTS	5	
LOCK	ERGONOMIC HANDLE WITH 3 mm DOUBLE BIT LOCK	
SUPPLY KIT	GROUNDING ACCESSORIES AND PALLET PACKING	
PACKAGING	CARDBOARD	
WEIGHT (PLATE EXCLUDED)	Kg	141,9
VOLUME	m ³	1,15

(OPTIONAL) INTERNAL PLATE	PLATE CODE	2 x FPE080180 + ZE001C
	MATERIAL	GALVANIZED STEEL
	WIDTH mm	1495
	HEIGHT mm	1730
	THICKNESS mm	2,5
	OVERALL SIZE mm	28
	WEIGHT Kg	76,2

POWER DISSIPATION TABLES

POWER DISSIPATION

MAXIMUM DISSIPABLE POWER IN WATT (W) FOR ALLOWED OVERTEMPERATURE (T °)
 VALUES (EXTERNAL TEMP. + OVERTEMPERATURE = 60 ° C)

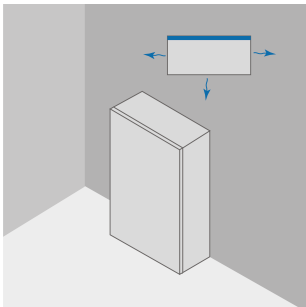

			REAR RAGAINST WALL			
W	H	D	OVERTEMPERATURE VALUES (dT)			
			25°C	30°C	35°C	40°C
mm	mm	mm	W	W	W	W
1600	1800	400	558	670	782	894

POWER DISSIPATION

MAXIMUM DISSIPABLE POWER IN WATT (W) FOR ALLOWED OVERTEMPERATURE (T °)
 VALUES (EXTERNAL TEMP. + OVERTEMPERATURE = 60 ° C)



			ALL SIDES FREE			
W	H	D	OVERTEMPERATURE VALUES (dT)			
			25°C	30°C	35°C	40°C
mm	mm	mm	W	W	W	W
1600	1800	400	581	697	814	930

download link CAD drawing: <https://www.compex.it/download/>