

PRODUCT DESCRIPTION



FCA08020050

COMPACT ENCLOSURE WITH SOLID DOOR

*representative image

TECHNICAL CHARACTERISTICS

PRODUCT CODE	FCA08020050	
DESCRIPTION	COMPACT ENCLOSURE WITH SOLID DOOR B800 X H2000 X P500	
MATERIAL	STAINLESS STEEL AISI 304 (1.4301)	
MATERIAL FINISHING	SCOTCH BRITE	
IP PROTECTION GRADE EN 60529	IP66	
IK RATING EN 62262	IK10	
NEMA RATING 250	4X	
UL/CSA UL508A CERTIFICATION, CSA C22.2 n° 14-13	NEMA 1.12.4.4X	
DIMENSIONS	WIDTH mm	800
	HEIGHT mm	2000
	DEPTH mm	500
FRAME	THICKNESS mm	1,5
	CONTINUOUSLY BENT AND WELDED SINGLE-STRUCTURE BODY	
DOOR	THICKNESS mm	1,5
	AIS1304 STAINLESS STEEL CONCEALED HINGES , OPENING SUP. 120° POLYURETHANE GASKET (TEMPERATURE RANGE: -40°C + 90°C)	
BACK	THICKNESS mm	1,5
SIDES	THICKNESS mm	-
ROOF	THICKNESS mm	-
NUMBER OF DOORS	1	
NUMBER OF HINGES	4	
HANDLES	1	
LOCKING POINTS	4	
LOCK	ERGONOMIC HANDLE WITH 3 mm DOUBLE BIT LOCK	
SUPPLY KIT	GROUNDING ACCESSORIES AND PALLET PACKING	
PACKAGING	CARDBOARD	
WEIGHT (PLATE EXCLUDED)	Kg	122,1
VOLUME	m ³	0,8

(OPTIONAL) INTERNAL PLATE	PLATE CODE	FPE080200
	MATERIAL	GALVANIZED STEEL
	WIDTH mm	695
	HEIGHT mm	1930
	THICKNESS mm	2,5
	OVERALL SIZE mm	28
	WEIGHT Kg	37,8

POWER DISSIPATION TABLES

POWER DISSIPATION

MAXIMUM DISSIPABLE POWER IN WATT (W) FOR ALLOWED OVERTEMPERATURE (T °)
 VALUES (EXTERNAL TEMP. + OVERTEMPERATURE = 60 ° C)

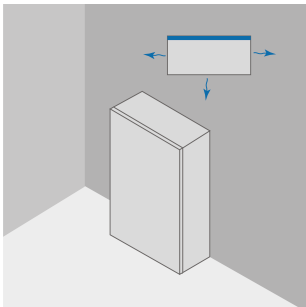

			REAR RAGAINST WALL			
W	H	D	OVERTEMPERATURE VALUES (dT)			
			25°C	30°C	35°C	40°C
mm	mm	mm	W	W	W	W
800	2000	500	413	495	578	660

POWER DISSIPATION

MAXIMUM DISSIPABLE POWER IN WATT (W) FOR ALLOWED OVERTEMPERATURE (T °)
 VALUES (EXTERNAL TEMP. + OVERTEMPERATURE = 60 ° C)



			ALL SIDES FREE			
W	H	D	OVERTEMPERATURE VALUES (dT)			
			25°C	30°C	35°C	40°C
mm	mm	mm	W	W	W	W
800	2000	500	427	512	598	683

download link CAD drawing: <https://www.compex.it/download/>