

## PRODUCT DESCRIPTION



# FCA06020050

COMPACT ENCLOSURE WITH SOLID DOOR

\*representative image

## TECHNICAL CHARACTERISTICS

<b>PRODUCT CODE</b>	FCA06020050	
<b>DESCRIPTION</b>	COMPACT ENCLOSURE WITH SOLID DOOR B600 X H2000 X P500	
<b>MATERIAL</b>	STAINLESS STEEL AISI 304 (1.4301)	
<b>MATERIAL FINISHING</b>	SCOTCH BRITE	
<b>IP PROTECTION GRADE EN 60529</b>	IP66	
<b>IK RATING EN 62262</b>	IK10	
<b>NEMA RATING 250</b>	4X	
<b>UL/CSA UL508A CERTIFICATION, CSA C22.2 n° 14-13</b>	NEMA 1.12.4.4X	
<b>DIMENSIONS</b>	WIDTH mm	600
	HEIGHT mm	2000
	DEPTH mm	500
<b>FRAME</b>	THICKNESS mm	1,5
	CONTINUOUSLY BENT AND WELDED SINGLE-STRUCTURE BODY	
<b>DOOR</b>	THICKNESS mm	1,5
	AIS1304 STAINLESS STEEL CONCEALED HINGES , OPENING SUP. 120° POLYURETHANE GASKET (TEMPERATURE RANGE: -40°C + 90°C)	
<b>BACK</b>	THICKNESS mm	1,5
<b>SIDES</b>	THICKNESS mm	-
<b>ROOF</b>	THICKNESS mm	-
<b>NUMBER OF DOORS</b>	1	
<b>NUMBER OF HINGES</b>	4	
<b>HANDLES</b>	1	
<b>LOCKING POINTS</b>	4	
<b>LOCK</b>	ERGONOMIC HANDLE WITH 3 mm DOUBLE BIT LOCK	
<b>SUPPLY KIT</b>	GROUNDING ACCESSORIES AND PALLET PACKING	
<b>PACKAGING</b>	CARDBOARD	
<b>WEIGHT (PLATE EXCLUDED)</b>	Kg	110,1
<b>VOLUME</b>	m <sup>3</sup>	0,6

<b>(OPTIONAL) INTERNAL PLATE</b>	<b>PLATE CODE</b>	FPE060200
	<b>MATERIAL</b>	GALVANIZED STEEL
	<b>WIDTH mm</b>	495
	<b>HEIGHT mm</b>	1930
	<b>THICKNESS mm</b>	2,5
	<b>OVERALL SIZE mm</b>	28
	<b>WEIGHT Kg</b>	28,2

## POWER DISSIPATION TABLES

### POWER DISSIPATION

MAXIMUM DISSIPABLE POWER IN WATT (W) FOR ALLOWED OVERTEMPERATURE (T °)  
 VALUES (EXTERNAL TEMP. + OVERTEMPERATURE = 60 ° C)

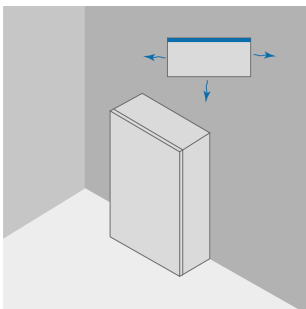

			REAR RAGAINST WALL			
			OVERTEMPERATURE VALUES (dT)			
W	H	D	25°C	30°C	35°C	40°C
mm	mm	mm	W	W	W	W
600	2000	500	350	420	490	560

### POWER DISSIPATION

MAXIMUM DISSIPABLE POWER IN WATT (W) FOR ALLOWED OVERTEMPERATURE (T °)  
 VALUES (EXTERNAL TEMP. + OVERTEMPERATURE = 60 ° C)



			ALL SIDES FREE			
			OVERTEMPERATURE VALUES (dT)			
W	H	D	25°C	30°C	35°C	40°C
mm	mm	mm	W	W	W	W
600	2000	500	361	434	506	577

download link CAD drawing: <https://www.compex.it/download/>