

PRODUCT DESCRIPTION



FCA06018040

COMPACT ENCLOSURE WITH SOLID DOOR

*representative image

TECHNICAL CHARACTERISTICS

PRODUCT CODE	FCA06018040	
DESCRIPTION	COMPACT ENCLOSURE WITH SOLID DOOR B600 X H1800 X P400	
MATERIAL	STAINLESS STEEL AISI 304 (1.4301)	
MATERIAL FINISHING	SCOTCH BRITE	
IP PROTECTION GRADE EN 60529	IP66	
IK RATING EN 62262	IK10	
NEMA RATING 250	4X	
UL/CSA UL508A CERTIFICATION, CSA C22.2 n° 14-13	NEMA 1.12.4.4X	
DIMENSIONS	WIDTH mm	600
	HEIGHT mm	1800
	DEPTH mm	400
FRAME	THICKNESS mm	1,5
	CONTINUOUSLY BENT AND WELDED SINGLE-STRUCTURE BODY	
DOOR	THICKNESS mm	1,5
	AIS1304 STAINLESS STEEL CONCEALED HINGES , OPENING SUP. 120° POLYURETHANE GASKET (TEMPERATURE RANGE: -40°C + 90°C)	
BACK	THICKNESS mm	1,5
SIDES	THICKNESS mm	-
ROOF	THICKNESS mm	-
NUMBER OF DOORS	1	
NUMBER OF HINGES	4	
HANDLES	1	
LOCKING POINTS	4	
LOCK	ERGONOMIC HANDLE WITH 3 mm DOUBLE BIT LOCK	
SUPPLY KIT	GROUNDING ACCESSORIES AND PALLET PACKING	
PACKAGING	CARDBOARD	
WEIGHT (PLATE EXCLUDED)	Kg	88,5
VOLUME	m ³	0,43

(OPTIONAL) INTERNAL PLATE	PLATE CODE	FPE060180
	MATERIAL	GALVANIZED STEEL
	WIDTH mm	495
	HEIGHT mm	1730
	THICKNESS mm	2,5
	OVERALL SIZE mm	28
	WEIGHT Kg	25,8

POWER DISSIPATION TABLES

POWER DISSIPATION

MAXIMUM DISSIPABLE POWER IN WATT (W) FOR ALLOWED OVERTEMPERATURE (T °)
 VALUES (EXTERNAL TEMP. + OVERTEMPERATURE = 60 ° C)

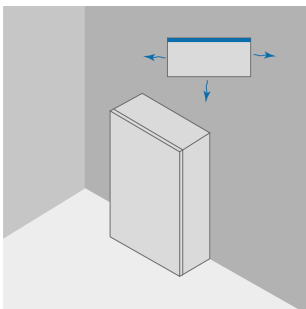

			REAR RAGAINST WALL			
W	H	D	OVERTEMPERATURE VALUES (dT)			
			25°C	30°C	35°C	40°C
mm	mm	mm	W	W	W	W
600	1800	400	282	339	395	451

POWER DISSIPATION

MAXIMUM DISSIPABLE POWER IN WATT (W) FOR ALLOWED OVERTEMPERATURE (T °)
 VALUES (EXTERNAL TEMP. + OVERTEMPERATURE = 60 ° C)



			ALL SIDES FREE			
W	H	D	OVERTEMPERATURE VALUES (dT)			
			25°C	30°C	35°C	40°C
mm	mm	mm	W	W	W	W
600	1800	400	291	349	407	465

download link CAD drawing: <https://www.compex.it/download/>