

## PRODUCT DESCRIPTION



# CLA08010030

ENCLOSURE WITH LEXAN DOOR

\*representative image

## TECHNICAL CHARACTERISTICS

<b>PRODUCT CODE</b>	CLA08010030	
<b>DESCRIPTION</b>	ENCLOSURE WITH LEXAN DOOR W800 X H1000 X D300	
<b>MATERIAL</b>	STAINLESS STEEL AISI 304 (1.4301)	
<b>MATERIAL FINISHING</b>	SCOTCH BRITE	
<b>IP PROTECTION GRADE EN 60529</b>	IP66	
<b>IK RATING EN 62262</b>	IK10	
<b>NEMA RATING 250</b>	4X	
<b>UL/CSA UL508A CERTIFICATION, CSA C22.2 n° 14-13</b>	NEMA 1.12.4.4X	
<b>DIMENSIONS</b>	WIDTH mm	800
	HEIGHT mm	1000
	DEPTH mm	300
<b>VIEWING DIMENSIONS</b>	WIDTH mm	749
	HEIGHT mm	960
<b>BODY</b>	THICKNESS mm	1.5
	SINGLE-BODY CONSTRUCTION BENT AND CONTINUOUSLY WELDED	
<b>DOOR</b>	THICKNESS mm	1.5
	AIS I 304 STAINLESS STEEL CONCEALED HINGES, DOOR OPENING GREATER THAN 120°	
	POLYURETHANE GASKET (RANGE TEMPERATURE: -40°C + 90°C)	
	PORTHOLE MATERIAL: LEXAN	
<b>NUMBER OF DOORS</b>	1	
<b>NUMBER OF HINGES</b>	3	
<b>NUMBER OF LOCKS</b>	3	
<b>LOCK</b>	CHROMED ZAMAK 3MM DOUBLE BIT LOCK	
<b>NUMBER OF REAR FIXING</b>	6	
<b>FIXING INSERT</b>	BLIND THREADED M6	
<b>REAR FIXING DISTANCE</b>	WIDTH mm	710
	HEIGHT mm	470
<b>SUPPLY KIT</b>	INTERNAL PLATE FIXING SCREWS KIT AND DOUBLE FIN KEY	
	GROUNDING SCREW KIT	
<b>PACKAGING</b>	CARDBOARD	
<b>WEIGHT (PLATE EXCLUDED)</b>	Kg	19.77
<b>VOLUME</b>	m <sup>3</sup>	0.24

**(OPTIONAL)  
INTERNAL PLATE**

<b>PLATE CODE</b>	CPE080100
<b>MATERIAL</b>	GALVANIZED STEEL
<b>WIDTH mm</b>	747
<b>HEIGHT mm</b>	970
<b>THICKNESS mm</b>	2.5
<b>ENCUMBRANCE mm</b>	14
<b>WEIGHT Kg</b>	24.03.00

## POWER DISSIPATION TABLES

### POWER DISSIPATION

MAXIMUM DISSIPABLE POWER IN WATT (W) FOR ALLOWED OVERTEMPERATURE (T °)  
 VALUES (EXTERNAL TEMP. + OVERTEMPERATURE = 60 ° C)

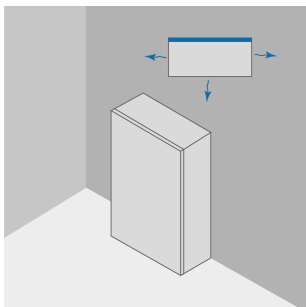

			REAR RAGAINST WALL			
W	H	D	OVERTEMPERATURE VALUES (dT)			
			25°C	30°C	35°C	40°C
mm	mm	mm	W	W	W	W
800	1000	300	195	234	222	312

### POWER DISSIPATION

MAXIMUM DISSIPABLE POWER IN WATT (W) FOR ALLOWED OVERTEMPERATURE (T °)  
 VALUES (EXTERNAL TEMP. + OVERTEMPERATURE = 60 ° C)



			ALL SIDES FREE			
W	H	D	OVERTEMPERATURE VALUES (dT)			
			25°C	30°C	35°C	40°C
mm	mm	mm	W	W	W	W
800	1000	300	150	180	171	240

download link CAD drawing: <https://www.compex.it/download/>