

PRODUCT DESCRIPTION



CLA03003021

ENCLOSURE WITH LEXAN DOOR

*representative image

TECHNICAL CHARACTERISTICS

PRODUCT CODE	CLA03003021	
DESCRIPTION	ENCLOSURE WITH LEXAN DOOR W300 X H300 X D210	
MATERIAL	STAINLESS STEEL AISI 304 (1.4301)	
MATERIAL FINISHING	SCOTCH BRITE	
IP PROTECTION GRADE EN 60529	IP66	
IK RATING EN 62262	IK10	
NEMA RATING 250	4X	
UL/CSA UL508A CERTIFICATION, CSA C22.2 n° 14-13	NEMA 1.12.4.4X	
DIMENSIONS	WIDTH mm	300
	HEIGHT mm	300
	DEPTH mm	210
VIEWING DIMENSIONS	WIDTH mm	249
	HEIGHT mm	260
BODY	THICKNESS mm	1.2
	SINGLE-BODY CONSTRUCTION BENT AND CONTINUOUSLY WELDED	
DOOR	THICKNESS mm	1.2
	AIS I 304 STAINLESS STEEL CONCEALED HINGES, DOOR OPENING GREATER THAN 120°	
	POLYURETHANE GASKET (RANGE TEMPERATURE: -40°C + 90°C)	
	PORTHOLE MATERIAL: LEXAN	
NUMBER OF DOORS	1	
NUMBER OF HINGES	2	
NUMBER OF LOCKS	1	
LOCK	CHROMED ZAMAK 3MM DOUBLE BIT LOCK	
NUMBER OF REAR FIXING	4	
FIXING INSERT	BLIND THREADED M6	
REAR FIXING DISTANCE	WIDTH mm	210
	HEIGHT mm	240
SUPPLY KIT	INTERNAL PLATE FIXING SCREWS KIT AND DOUBLE FIN KEY	
	GROUNDING SCREW KIT	
PACKAGING	CARDBOARD	
WEIGHT (PLATE EXCLUDED)	Kg	2.00
VOLUME	m ³	0.02

**(OPTIONAL)
INTERNAL PLATE**

PLATE CODE	CPE030030
MATERIAL	GALVANIZED STEEL
WIDTH mm	247
HEIGHT mm	270
THICKNESS mm	2.5
ENCUMBRANCE mm	-
WEIGHT Kg	24.03.00

POWER DISSIPATION TABLES

POWER DISSIPATION

MAXIMUM DISSIPABLE POWER IN WATT (W) FOR ALLOWED OVERTEMPERATURE (T °)
VALUES (EXTERNAL TEMP. + OVERTEMPERATURE = 60 ° C)

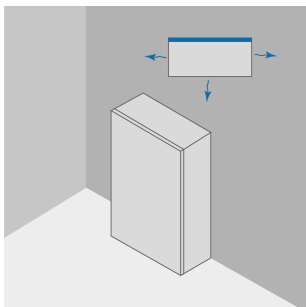

			REAR RAGAINST WALL			
W	H	D	OVERTEMPERATURE VALUES (dT)			
			25°C	30°C	35°C	40°C
mm	mm	mm	W	W	W	W
300	300	210	34	41	48	55

POWER DISSIPATION

MAXIMUM DISSIPABLE POWER IN WATT (W) FOR ALLOWED OVERTEMPERATURE (T °)
VALUES (EXTERNAL TEMP. + OVERTEMPERATURE = 60 ° C)



			ALL SIDES FREE			
W	H	D	OVERTEMPERATURE VALUES (dT)			
			25°C	30°C	35°C	40°C
mm	mm	mm	W	W	W	W
300	300	210	29	35	41	48

download link CAD drawing: <https://www.compex.it/download/>